

PROJECT DETAILS

PROJECT:

TYPE:

NOTES:



FEATURES

- + Precision reflector with clear lens - for better light distribution.
- + Adjustable up to 40° and rotatable up to 350°
- + Specially designed heat sink - for class leading heat dissipation.
- + Suitable for concrete install with concrete canister (*ordered separately*)
- + Flicker-free Driver
- + Black baffle design - eliminates glare for optimum visual comfort.
- + Compatible with remote Casambi CBU-TED Bluetooth Controllable Dimmer (71-CASCBU) & with Casambi BasicDim Driver 11W (71-CAS300)

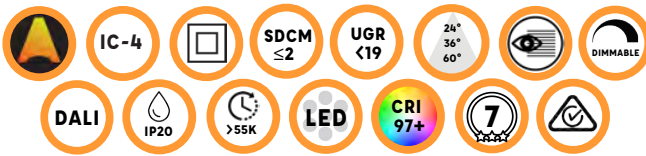

GENERAL SPECIFICATIONS

LED	11W *operating wattage 12W
Lumens	965 lm (3000K) 1014 lm (4000K)
Efficacy	75 lm/w (3000K) 79 lm/w (4000K)
Colour Temperature	<input type="checkbox"/> 3000K, Warm White <input type="checkbox"/> 4000K, Cool White
Material	Powder Coated Aluminium
Finish	White Black
Beam	24° 36° 60°
CRI	97+
IP	20
Colour Deviation	SDCM ≤2
UGR	<19
Lifetime	>55,000hrs L80 B10
Warranty	7 Years

DIMENSIONS (mm)

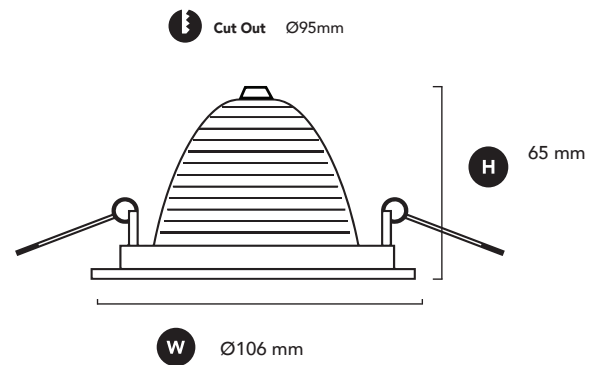

DRIVER SPECIFICATIONS

L 98 x W 38 x H 24 mm

Power	300mA 240V Remote, Flicker Free Dimmable Driver
Dimming	Phase Cut Dimming
Power Factor	> 0.90

DALI dimming available upon request

PRODUCT CODES

White, 3000K, 60°	118-PR7AR11W603
White, 4000K, 60°	118-PR7AR11W604
Black, 3000K, 60°	118-PR7AR11B603
Black, 4000K, 60°	118-PR7AR11B604

REFLECTOR CODES

24° Reflector	118-RFLA24
36° Reflector	118-RFLA36

Please Note: When using C-Bus, use universal or trailing edge dimming modules