

Materials



anodized aluminium



bronze anodized



black anodized



carrara marble



onyx



bronze amani marble



sahara noir marble



bronze



copper



glass

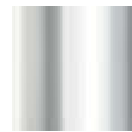

polished aluminium



corian



polished stainless steel



painting aluminium

Colours



bordeaux



black

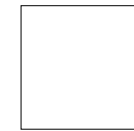

arctic white



sand



gray



mustard yellow



aquamarine



olive green

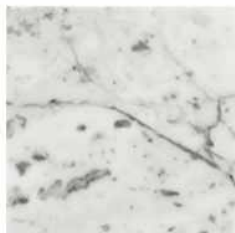

Venatino



Bianco Carrara



Crema Valencia



Azul Macaubas

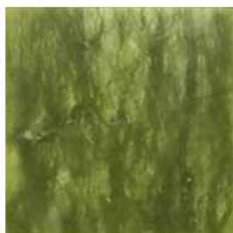

Ming Green



Bronze Amani



Black and Gold



Emperador Dark















Kenya Black



Foussana



Sahara Noir

L	Length
W	Width
H	Height
Ø	Diameter
	
	~240V
	Product conform to European Community Directive
	Product conform te EAC
	Fixable to ceiling
	Fixable to wall
	Floor lamp
	Desk lamp
	LED
	Only basic insulation, accessible conductors are earthed. Earthing:
	compulsory. Lights are fixable to fiery surface directly
	Protection class 3, fixture delivered without transformer. Use with electronic transformers only

I N **A R C H I** I

Products

